

Varenummer: 2031100M850B3S
 Beskrivelse: E+G Justerfod
 GN 31-100-M8-50-B3-S
 Note: S Uden møtrik, udvendig sekskant i bunden

Mål

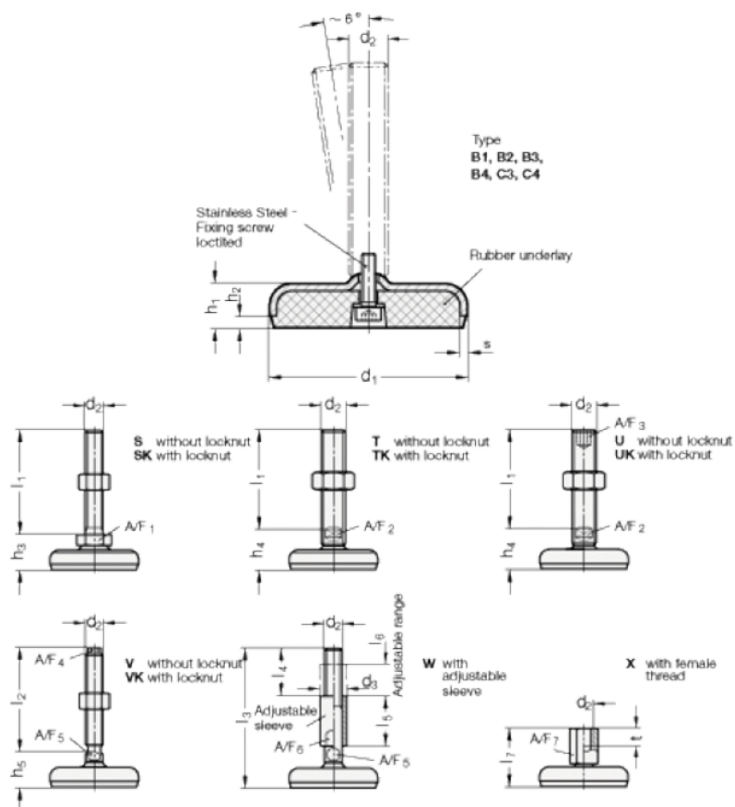

A/F1-	= 17
d1	= 100
d2	= 8
h1	= 20
h2	= 6
h3 +4.0/0	= 28
l1	= 50
s	= 3